

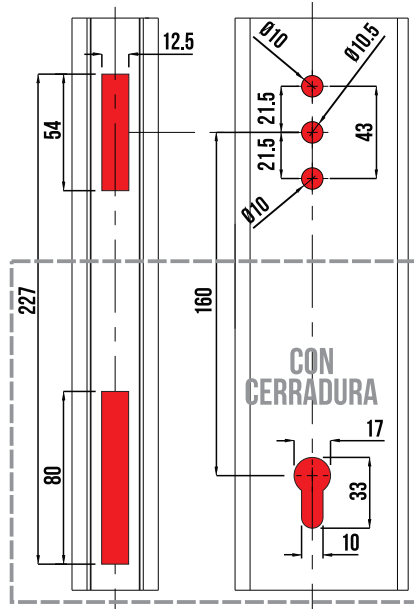

C/L 1.60M

MAQUINADO

PARA CREMONA CUADRADILLO



PARA CIERRE OCULTO "PULL UP"

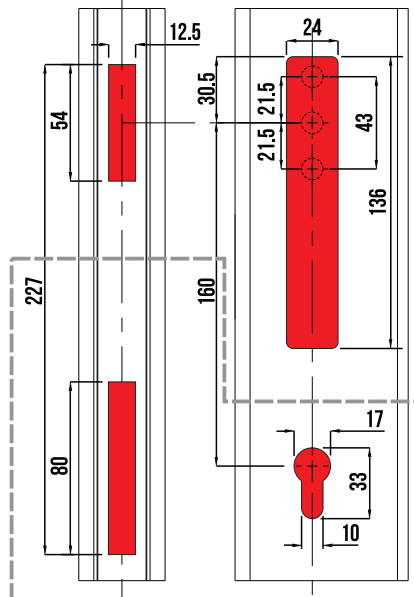

LINEAS INDALUM

S-4500

Componentes			
Cremona F-608	Suplemento MUC	Chapa Cerradero MUCC	Cerradero MUCE

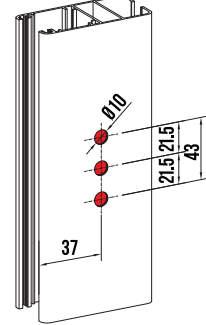
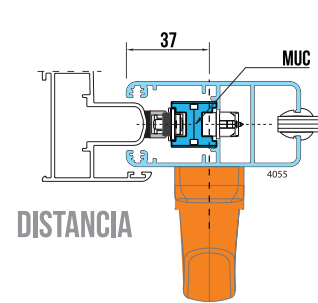

STAC

COMPONENTES

MUC

PIJA

MUCC

MUCE

F-608

F-77102R

MAQUINADO CREMONA

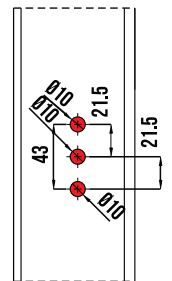

F-628

MAQUINADO CREMONA

B-7100

MAQUINADO CREMONA

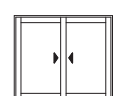
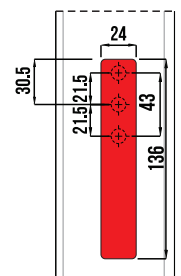
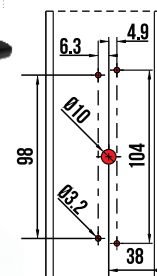

Piezas

Materiales

Aluminio, zamak y acero inox

Acabados

Lacado y anodizado.

Empaquetado



Qty: 100

Observaciones: Herramientas no incluido